



# TR2/16





Codice testa  
Head code

Codice mandrino  
Spindle code

 N° prese di moto  
Nr. spindle drives 10

 Rapporto  
Ratio 1-1

 Capacità di foratura  
Drilling capacity  
acciaio R=500 N/mm<sup>2</sup> 16  
ghisa: GG25 18

 Maschiatura  
Tapping M14

 Attacco utensile  
Type of spindle  
D DIN 55058 Ø25

 Peso gruppo testa  
Head weight Kg 31

 Peso gruppo mandrino  
Spindle-set weight Kg 3,3

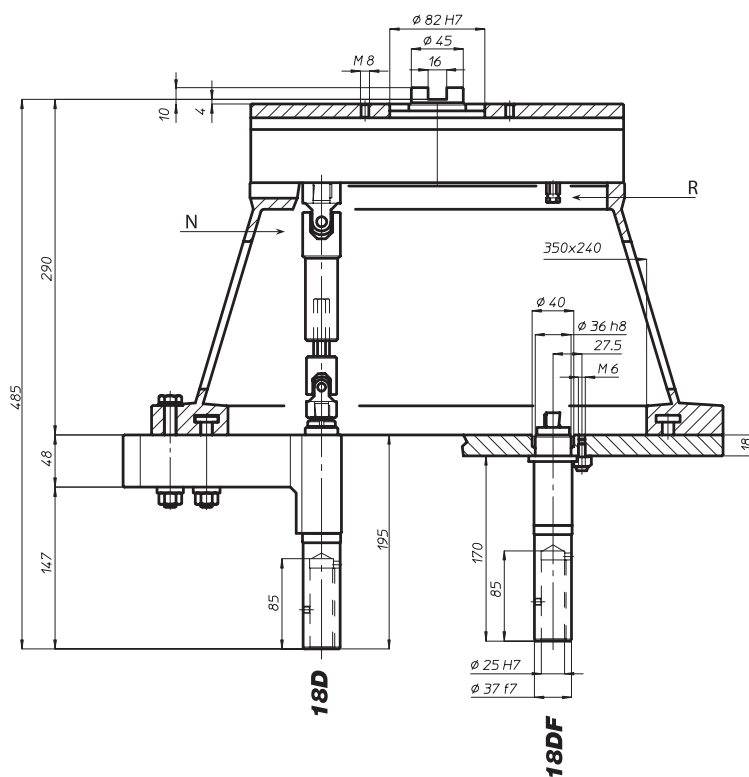
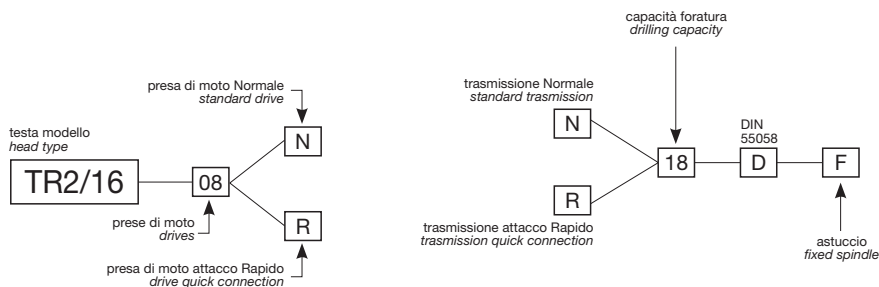

area di lavoro  
working area

